

SUPER FLOODLIGHT

RL SUPER FLOODLIGHT: THE BEST QUALITY EVER SEEN!



SUPER FLOODLIGHT 100W

RL SUPER FLOODLIGHT: THE BEST QUALITY EVER SEEN!

The RL Super Floodlight is the premium best product of our outdoor catalogue. With a power range between 100W and 3.000W and an opening angle from 10° to 120°, it is the ideal product for outdoor applications from football field to highway tunnels.

RL SUPER FLOODLIGHT: LA MIGLIORE QUALITÀ MAI VISTA PRIMA!

La RL Super Floodlight è il miglior prodotto presente nel nostro catalogo da esterno. Con un range di potenza compreso tra 100W e 3.000W e un angolo di apertura da 10° a 120° è il prodotto ideale per le applicazioni esterne, dal campo da calcio alle gallerie autostradali.

RL SUPER FLOODLIGHT: BESTE QUALITÄT NOCH NIE GESEHEN!

Die RL Super Floodlight sind die besten Produkte zur äußerlichen Anwendung in unserem Katalog.

Mit einer Skala von Leistung zwischen 100W und 3.000W und Öffnungswinkel von 10° bis 120°, dieser LED-Strahler ist das beste Produkt für Außenbereiche, von Fußballplatz bis Autobahntunnel.

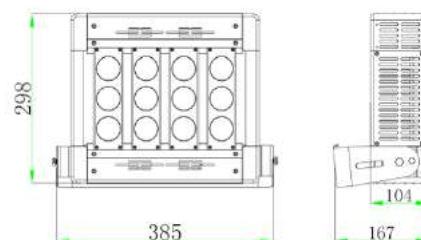

C.R.I. COMPARISON



OUR SUPER FLOODLIGHT CRI>85

NORMAL LIGHT C.R.I. 70



TECHNICAL DATA

ARTICLE NUMBER	RL-100-WW-XX	RL-100-NW-XX	RL-100-CW-XX
NAME OF PRODUCT	SUPER FLOODLIGHT 100W		
INNER CARTON	1	1	1
MASTER CARTON	1	1	1
WEIGHT SINGLE PIECE	7 Kg	7 Kg	7 Kg

GENERAL CHARACTERISTICS

MAIN APPLICATION	Sport field, Stadium, Tunnel, Light tower	Sport field, Stadium, Tunnel, Light tower	Sport field, Stadium, Tunnel, Light tower
NOMINAL LIFETIME	> 80.000 hours	> 80.000 hours	> 80.000 hours
SOURCE (LED TYPE)	12 CREE Xlamp	12 CREE Xlamp	12 CREE Xlamp
IP RATE	IP 67	IP 67	IP 67

LIGHTING DATA

COLOR TEMPERATURE	3.000K	4.000K	5.700K
CRI	>88	>88	>88
LUMINOUS FLUX	>14.000 Lm	>15.000 Lm	>16.000 Lm
LLMF (LUMEN MAINTENANCE)	70% AFTER 50.000 hrs	70% AFTER 50.000 hrs	70% AFTER 50.000 hrs
RATED BEAM ANGLE	10°(XX=10), 24°(XX=24), 38°(XX=38), 60°(XX=60), 90°(XX=90), 120°(XX=120)		

ELECTRICAL DATA

SYSTEM POWER	100W	100W	100W
START TIME (SECOND)	<1 S	<1 S	<1 S
WARM-UP TIME TO 60% LIGHT OUTPUT	INSTANT FULL LIGHT	INSTANT FULL LIGHT	INSTANT FULL LIGHT
INPUT VOLTAGE	AC 90-305V	AC 90-305V	AC 90-305V
FREQUENCY	50/60 Hz	50/60 Hz	50/60 Hz
POWER FACTOR	> 95	> 95	> 95
DIMMABLE		1-10V, TRIAC AND DALI AVAILABLE	
ENERGY SAVING	YES	YES	YES
WORKING TEMPERATURE	-40°/65°C	-40°/65°C	-40°/65°C
HUMIDITY	10-90%	10-90%	10-90%

DIMENSION

DIMENSION OF THE PRODUCT	298*385*104 mm	298*385*104 mm	298*385*104 mm
CUTOUT	NONE	NONE	NONE

APPROVAL & APPLICATIONS CHARS

VDE MARKING	IN PROCESS	IN PROCESS	IN PROCESS
CE MARKING	YES	YES	YES
UL MARKING	IN PROCESS	IN PROCESS	IN PROCESS
ROHS COMPLIANCE	YES	YES	YES



SUPER FLOODLIGHT 150W

RL SUPER FLOODLIGHT: THE BEST QUALITY EVER SEEN!

The RL Super Floodlight is the premium best product of our outdoor catalogue. With a power range between 100W and 3.000W and an opening angle from 10° to 120°, it is the ideal product for outdoor applications from football field to highway tunnels.

RL SUPER FLOODLIGHT: LA MIGLIORE QUALITÀ MAI VISTA PRIMA!

La RL Super Floodlight è il miglior prodotto presente nel nostro catalogo da esterno. Con un range di potenza compreso tra 100W e 3.000W e un angolo di apertura da 10° a 120° è il prodotto ideale per le applicazioni esterne, dal campo da calcio alle gallerie autostradali.

RL SUPER FLOODLIGHT: BESTE QUALITÄT NOCH NIE GESEHEN!

Die RL Super Floodlight sind die besten Produkte zur äußerlichen Anwendung in unserem Katalog.

Mit einer Skala von Leistung zwischen 100W und 3.000W und Öffnungswinkel von 10° bis 120°, dieser LED-Strahler ist das beste Produkt für Außenbereiche, von Fußballplatz bis Autobahntunnel.

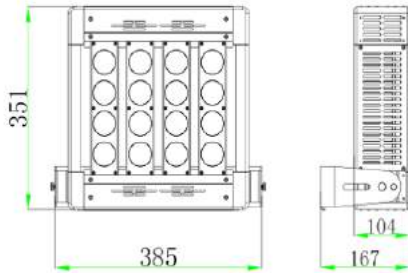

C.R.I. COMPARISON

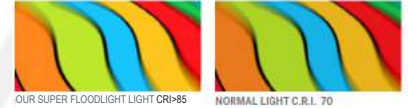

TECHNICAL DATA

ARTICLE NUMBER	RL-150-WW-XX	RL-150-NW-XX	RL-150-CW-XX
NAME OF PRODUCT		SUPER FLOODLIGHT 150W	
INNER CARTON	1	1	1
MASTER CARTON	1	1	1
WEIGHT SINGLE PIECE	8 Kg	8 Kg	8 Kg

GENERAL CHARACTERISTICS

MAIN APPLICATION	Sport field, Stadium, Tunnel, Light tower	Sport field, Stadium, Tunnel, Light tower	Sport field, Stadium, Tunnel, Light tower
NOMINAL LIFETIME	> 80.000 hours	> 80.000 hours	> 80.000 hours
SOURCE (LED TYPE)	18 CREE Xlamp	18 CREE Xlamp	18 CREE Xlamp
IP RATE	IP 67	IP 67	IP 67

LIGHTING DATA

COLOR TEMPERATURE	3.000K	4.000K	5.700K
CRI	>88	>88	>88
LUMINOUS FLUX	>21.000 Lm	>22.500 Lm	>24.000 Lm
LLMF (LUMEN MAINTENANCE)	70% AFTER 50.000 hrs	70% AFTER 50.000 hrs	70% AFTER 50.000 hrs
RATED BEAM ANGLE	10°(XX=10), 24°(XX=24), 38°(XX=38), 60°(XX=60), 90°(XX=90), 120°(XX=120)		

ELECTRICAL DATA

SYSTEM POWER	150W	150W	150W
START TIME (SECOND)	<1 S	<1 S	<1 S
WARM-UP TIME TO 60% LIGHT OUTPUT	INSTANT FULL LIGHT	INSTANT FULL LIGHT	INSTANT FULL LIGHT
INPUT VOLTAGE	AC 90-305V	AC 90-305V	AC 90-305V
FREQUENCY	50/60 Hz	50/60 Hz	50/60 Hz
POWER FACTOR	> 95	> 95	> 95
DIMMABLE		1-10V, TRIAC AND DALI AVAILABLE	
ENERGY SAVING	YES	YES	YES
WORKING TEMPERATURE	-40°/65°C	-40°/65°C	-40°/65°C
HUMIDITY	10-90%	10-90%	10-90%

DIMENSION

DIMENSION OF THE PRODUCT	351*385*104 mm	351*385*104 mm	351*385*104 mm
CUTOUT	NONE	NONE	NONE

APPROVAL & APPLICATIONS CHARS

VDE MARKING	IN PROCESS	IN PROCESS	IN PROCESS
CE MARKING	YES	YES	YES
UL MARKING	IN PROCESS	IN PROCESS	IN PROCESS
ROHS COMPLIANCE	YES	YES	YES

SUPERFLOODLIGHT 200W

RL SUPER FLOODLIGHT: THE BEST QUALITY EVER SEEN!

The RL Super Floodlight is the premium best product of our outdoor catalogue. With a power range between 100W and 3.000W and an opening angle from 10° to 120°, it is the ideal product for outdoor applications from football field to highway tunnels.

RL SUPER FLOODLIGHT: LA MIGLIORE QUALITÀ MAI VISTA PRIMA!

La RL Super Floodlight è il miglior prodotto presente nel nostro catalogo da esterno. Con un range di potenza compreso tra 100W e 3.000W e un angolo di apertura da 10° a 120° è il prodotto ideale per le applicazioni esterne, dal campo da calcio alle gallerie autostradali.

RL SUPER FLOODLIGHT: BESTE QUALITÄT NOCH NIE GESEHEN!

Die RL Super Floodlight sind die besten Produkte zur äußerlichen Anwendung in unserem Katalog.

Mit einer Skala von Leistung zwischen 100W und 3.000W und Öffnungswinkel von 10° bis 120°, dieser LED-Strahler ist das beste Produkt für Außenbereiche, von Fußballplatz bis Autobahntunnel.

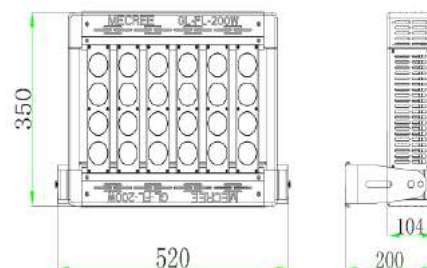

C.R.I. COMPARISON

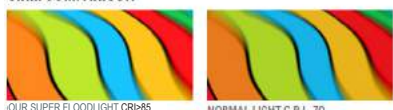

TECHNICAL DATA

ARTICLE NUMBER	RL-200-WW-XX	RL-200-NW-XX	RL-200-CW-XX
NAME OF PRODUCT		SUPER FLOODLIGHT 200W	
INNER CARTON	1	1	1
MASTER CARTON	1	1	1
WEIGHT SINGLE PIECE	10 Kg	10 Kg	10 Kg

GENERAL CHARACTERISTICS

MAIN APPLICATION	Sport field, Stadium, Tunnel, Light tower	Sport field, Stadium, Tunnel, Light tower	Sport field, Stadium, Tunnel, Light tower
NOMINAL LIFETIME	> 80.000 hours	> 80.000 hours	> 80.000 hours
SOURCE (LED TYPE)	24 CREE Xlamp	24 CREE Xlamp	24 CREE Xlamp
IP RATE	IP 67	IP 67	IP 67

LIGHTING DATA

COLOR TEMPERATURE	3.000K	4.000K	5.700K
CRI	>88	>88	>88
LUMINOUS FLUX	>28.500 Lm	>30.000 Lm	>31.500 Lm
LLMF (LUMEN MAINTENANCE)	70% AFTER 50.000 hrs	70% AFTER 50.000 hrs	70% AFTER 50.000 hrs
RATED BEAM ANGLE	10°(XX=10), 24°(XX=24), 38°(XX=38), 60°(XX=60), 90°(XX=90), 120°(XX=120)		

ELECTRICAL DATA

SYSTEM POWER	200W	200W	200W
START TIME (SECOND)	<1 S	<1 S	<1 S
WARM-UP TIME TO 60% LIGHT OUTPUT	INSTANT FULL LIGHT	INSTANT FULL LIGHT	INSTANT FULL LIGHT
INPUT VOLTAGE	AC 90-305V	AC 90-305V	AC 90-305V
FREQUENCY	50/60 Hz	50/60 Hz	50/60 Hz
POWER FACTOR	> 95	> 95	> 95
DIMMABLE		1-10V, TRIAC AND DALI AVAILABLE	
ENERGY SAVING	YES	YES	YES
WORKING TEMPERATURE	-40°/65°C	-40°/65°C	-40°/65°C
HUMIDITY	10-90%	10-90%	10-90%

DIMENSION

DIMENSION OF THE PRODUCT	350*520*104 mm	350*520*104 mm	350*520*104 mm
CUTOUT	NONE	NONE	NONE

APPROVAL & APPLICATIONS CHARS

VDE MARKING	IN PROCESS	IN PROCESS	IN PROCESS
CE MARKING	YES	YES	YES
UL MARKING	IN PROCESS	IN PROCESS	IN PROCESS
ROHS COMPLIANCE	YES	YES	YES

SUPER FLOODLIGHT 300W

RL SUPER FLOODLIGHT: THE BEST QUALITY EVER SEEN!

The RL Super Floodlight is the premium best product of our outdoor catalogue. With a power range between 100W and 3.000W and an opening angle from 10° to 120°, it is the ideal product for outdoor applications from football field to highway tunnels.

RL SUPER FLOODLIGHT: LA MIGLIORE QUALITÀ MAI VISTA PRIMA!

La RL Super Floodlight è il miglior prodotto presente nel nostro catalogo da esterno. Con un range di potenza compreso tra 100W e 3.000W e un angolo di apertura da 10° a 120° è il prodotto ideale per le applicazioni esterne, dal campo da calcio alle gallerie autostradali.

RL SUPER FLOODLIGHT: BESTE QUALITÄT NOCH NIE GESEHEN!

Die RL Super Floodlight sind die besten Produkte zur äußerlichen Anwendung in unserem Katalog.

Mit einer Skala von Leistung zwischen 100W und 3.000W und Öffnungswinkel von 10° bis 120°, dieser LED-Strahler ist das beste Produkt für Außenbereiche, von Fußballplatz bis Autobahntunnel.

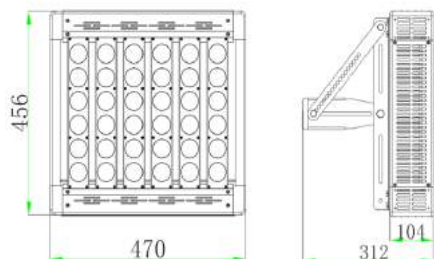

C.R.I. COMPARISON

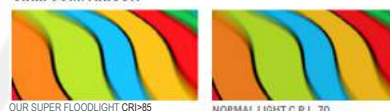

TECHNICAL DATA

ARTICLE NUMBER	RL-300-WW-XX	RL-300-NW-XX	RL-300-CW-XX
NAME OF PRODUCT	SUPER FLOODLIGHT 300W		
INNER CARTON	1	1	1
MASTER CARTON	1	1	1
WEIGHT SINGLE PIECE	15 Kg	15 Kg	15 Kg

GENERAL CHARACTERISTICS

MAIN APPLICATION	Sport field, Stadium, Tunnel, Light tower	Sport field, Stadium, Tunnel, Light tower	Sport field, Stadium, Tunnel, Light tower
NOMINAL LIFETIME	> 80.000 hours	> 80.000 hours	> 80.000 hours
SOURCE (LED TYPE)	36 CREE Xlamp	36 CREE Xlamp	36 CREE Xlamp
IP RATE	IP 67	IP 67	IP 67

LIGHTING DATA

COLOR TEMPERATURE	3.000K	4.000K	5.700K
CRI	>88	>88	>88
LUMINOUS FLUX	>42.750 Lm	>45.000 Lm	>47.250 Lm
LLMF (LUMEN MAINTENANCE)	70% AFTER 50.000 hrs	70% AFTER 50.000 hrs	70% AFTER 50.000 hrs
RATED BEAM ANGLE	10°(XX=10), 24°(XX=24), 38°(XX=38), 60°(XX=60), 90°(XX=90), 120°(XX=120)		

ELECTRICAL DATA

SYSTEM POWER	300W	300W	300W
START TIME (SECOND)	<1 S	<1 S	<1 S
WARM-UP TIME TO 60% LIGHT OUTPUT	INSTANT FULL LIGHT	INSTANT FULL LIGHT	INSTANT FULL LIGHT
INPUT VOLTAGE	AC 90-305V	AC 90-305V	AC 90-305V
FREQUENCY	50/60 Hz	50/60 Hz	50/60 Hz
POWER FACTOR	> 95	> 95	> 95
DIMMABLE		1-10V, TRIAC AND DALI AVAILABLE	
ENERGY SAVING	YES	YES	YES
WORKING TEMPERATURE	-40°/65°C	-40°/65°C	-40°/65°C
HUMIDITY	10-90%	10-90%	10-90%

DIMENSION

DIMENSION OF THE PRODUCT	456*470*104 mm	456*470*104 mm	456*470*104 mm
CUTOUT	NONE	NONE	NONE

APPROVAL & APPLICATIONS CHARS

VDE MARKING	IN PROCESS	IN PROCESS	IN PROCESS
CE MARKING	YES	YES	YES
UL MARKING	IN PROCESS	IN PROCESS	IN PROCESS
ROHS COMPLIANCE	YES	YES	YES

SUPER FLOODLIGHT 400W

RL SUPER FLOODLIGHT: THE BEST QUALITY EVER SEEN!

The RL Super Floodlight is the premium best product of our outdoor catalogue. With a power range between 100W and 3.000W and an opening angle from 10° to 120°, it is the ideal product for outdoor applications from football field to highway tunnels.

RL SUPER FLOODLIGHT: LA MIGLIORE QUALITÀ MAI VISTA PRIMA!

La RL Super Floodlight è il miglior prodotto presente nel nostro catalogo da esterno. Con un range di potenza compreso tra 100W e 3.000W e un angolo di apertura da 10° a 120° è il prodotto ideale per le applicazioni esterne, dal campo da calcio alle gallerie autostradali.

RL SUPER FLOODLIGHT: BESTE QUALITÄT NOCH NIE GESEHEN!

Die RL Super Floodlight sind die besten Produkte zur äußerlichen Anwendung in unserem Katalog.

Mit einer Skala von Leistung zwischen 100W und 3.000W und Öffnungswinkel von 10° bis 120°, dieser LED-Strahler ist das beste Produkt für Außenbereiche, von Fußballplatz bis Autobahntunnel.

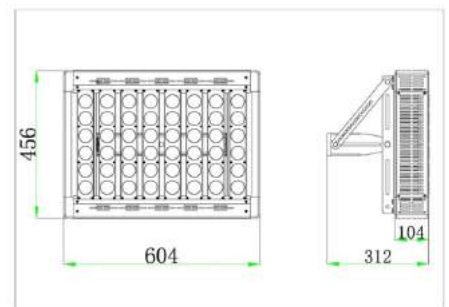

C.R.I. COMPARISON



OUR SUPERFLOOD LIGHT CRI>85

NORMAL LIGHT C.R.I. 70



TECHNICAL DATA

ARTICLE NUMBER	RL-400-WW-XX	RL-400-NW-XX	RL-400-CW-XX
NAME OF PRODUCT	SUPER FLOODLIGHT 400W		
INNER CARTON	1	1	1
MASTER CARTON	1	1	1
WEIGHT SINGLE PIECE	18 Kg	18 Kg	18 Kg

GENERAL CHARACTERISTICS

MAIN APPLICATION	Sport field, Stadium, Tunnel, Light tower	Sport field, Stadium, Tunnel, Light tower	Sport field, Stadium, Tunnel, Light tower
NOMINAL LIFETIME	> 80.000 hours	> 80.000 hours	> 80.000 hours
SOURCE (LED TYPE)	48 CREE Xlamp	48 CREE Xlamp	48 CREE Xlamp
IP RATE	IP 67	IP 67	IP 67

LIGHTING DATA

COLOR TEMPERATURE	3.000K	4.000K	5.700K
CRI	>88	>88	>88
LUMINOUS FLUX	>57.000 Lm	>60.000 Lm	>63.000 Lm
LLMF (LUMEN MAINTENANCE)	70% AFTER 50.000 hrs	70% AFTER 50.000 hrs	70% AFTER 50.000 hrs
RATED BEAM ANGLE	10°(XX=10), 24°(XX=24), 38°(XX=38), 60°(XX=60), 90°(XX=90), 120°(XX=120)		

ELECTRICAL DATA

SYSTEM POWER	400W	400W	400W
START TIME (SECOND)	<1 S	<1 S	<1 S
WARM-UP TIME TO 60% LIGHT OUTPUT	INSTANT FULL LIGHT	INSTANT FULL LIGHT	INSTANT FULL LIGHT
INPUT VOLTAGE	AC 90-305V	AC 90-305V	AC 90-305V
FREQUENCY	50/60 Hz	50/60 Hz	50/60 Hz
POWER FACTOR	> 95	> 95	> 95
DIMMABLE		1-10V, TRIAC AND DALI AVAILABLE	
ENERGY SAVING	YES	YES	YES
WORKING TEMPERATURE	-40°/65°C	-40°/65°C	-40°/65°C
HUMIDITY	10-90%	10-90%	10-90%

DIMENSION

DIMENSION OF THE PRODUCT	456*604*104 mm	456*604*104 mm	456*604*104 mm
CUTOUT	NONE	NONE	NONE

APPROVAL & APPLICATIONS CHARS

VDE MARKING	IN PROCESS	IN PROCESS	IN PROCESS
CE MARKING	YES	YES	YES
UL MARKING	IN PROCESS	IN PROCESS	IN PROCESS
ROHS COMPLIANCE	YES	YES	YES

SUPER FLOODLIGHT 500W

RL SUPER FLOODLIGHT: THE BEST QUALITY EVER SEEN!

The RL Super Floodlight is the premium best product of our outdoor catalogue. With a power range between 100W and 3.000W and an opening angle from 10° to 120°, it is the ideal product for outdoor applications from football field to highway tunnels.

RL SUPER FLOODLIGHT: LA MIGLIORE QUALITÀ MAI VISTA PRIMA!

La RL Super Floodlight è il miglior prodotto presente nel nostro catalogo da esterno. Con un range di potenza compreso tra 100W e 3.000W e un angolo di apertura da 10° a 120° è il prodotto ideale per le applicazioni esterne, dal campo da calcio alle gallerie autostradali.

RL SUPER FLOODLIGHT: BESTE QUALITÄT NOCH NIE GESEHEN!

Die RL Super Floodlight sind die besten Produkte zur äußerlichen Anwendung in unserem Katalog.

Mit einer Skala von Leistung zwischen 100W und 3.000W und Öffnungswinkel von 10° bis 120°, dieser LED-Strahler ist das beste Produkt für Außenbereiche, von Fußballplatz bis Autobahntunnel.

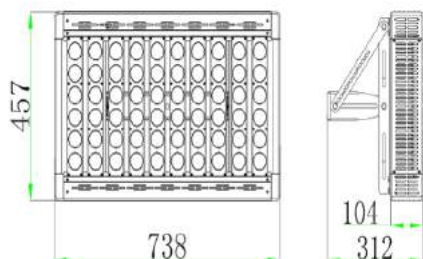

C.R.I. COMPARISON

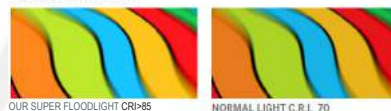

TECHNICAL DATA

ARTICLE NUMBER	RL-500-WW-XX	RL-500-NW-XX	RL-500-CW-XX
NAME OF PRODUCT	SUPER FLOODLIGHT 500W		
INNER CARTON	1	1	1
MASTER CARTON	1	1	1
WEIGHT SINGLE PIECE	21 Kg	21 Kg	21 Kg

GENERAL CHARACTERISTICS

MAIN APPLICATION	Sport field, Stadium, Tunnel, Light tower	Sport field, Stadium, Tunnel, Light tower	Sport field, Stadium, Tunnel, Light tower
NOMINAL LIFETIME	> 80.000 hours	> 80.000 hours	> 80.000 hours
SOURCE (LED TYPE)	60 CREE Xlamp	60 CREE Xlamp	60 CREE Xlamp
IP RATE	IP 67	IP 67	IP 67

LIGHTING DATA

COLOR TEMPERATURE	3.000K	4.000K	5.700K
CRI	>88	>88	>88
LUMINOUS FLUX	>71.250 Lm	>75.000 Lm	>78.750 Lm
LLMF (LUMEN MAINTENANCE)	70% AFTER 50.000 hrs	70% AFTER 50.000 hrs	70% AFTER 50.000 hrs
RATED BEAM ANGLE	10°(XX=10), 24°(XX=24), 38°(XX=38), 60°(XX=60), 90°(XX=90), 120°(XX=120)		

ELECTRICAL DATA

SYSTEM POWER	500W	500W	500W
START TIME (SECOND)	<1 S	<1 S	<1 S
WARM-UP TIME TO 60% LIGHT OUTPUT	INSTANT FULL LIGHT	INSTANT FULL LIGHT	INSTANT FULL LIGHT
INPUT VOLTAGE	AC 90-305V	AC 90-305V	AC 90-305V
FREQUENCY	50/60 Hz	50/60 Hz	50/60 Hz
POWER FACTOR	> 95	> 95	> 95
DIMMABLE	1-10V, TRIAC AND DALI AVAILABLE		
ENERGY SAVING	YES	YES	YES
WORKING TEMPERATURE	-40°/65°C	-40°/65°C	-40°/65°C
HUMIDITY	10-90%	10-90%	10-90%

DIMENSION

DIMENSION OF THE PRODUCT	457*738*104 mm	457*738*104 mm	457*738*104 mm
CUTOUT	NONE	NONE	NONE

APPROVAL & APPLICATIONS CHARS

VDE MARKING	IN PROCESS	IN PROCESS	IN PROCESS
CE MARKING	YES	YES	YES
UL MARKING	IN PROCESS	IN PROCESS	IN PROCESS
ROHS COMPLIANCE	YES	YES	YES

SUPER FLOODLIGHT 600W

RL SUPER FLOODLIGHT: THE BEST QUALITY EVER SEEN!

The RL Super Floodlight is the premium best product of our outdoor catalogue. With a power range between 100W and 3.000W and an opening angle from 10° to 120°, it is the ideal product for outdoor applications from football field to highway tunnels.

RL SUPER FLOODLIGHT: LA MIGLIORE QUALITÀ MAI VISTA PRIMA!

La RL Super Floodlight è il miglior prodotto presente nel nostro catalogo da esterno. Con un range di potenza compreso tra 100W e 3.000W e un angolo di apertura da 10° a 120° è il prodotto ideale per le applicazioni esterne, dal campo da calcio alle gallerie autostradali.

RL SUPER FLOODLIGHT: BESTE QUALITÄT NOCH NIE GESEHEN!

Die RL Super Floodlight sind die besten Produkte zur äußerlichen Anwendung in unserem Katalog.

Mit einer Skala von Leistung zwischen 100W und 3.000W und Öffnungswinkel von 10° bis 120°, dieser LED-Strahler ist das beste Produkt für Außenbereiche, von Fußballplatz bis Autobahntunnel.

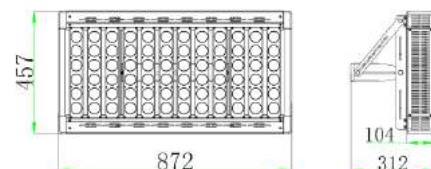

C.R.I. COMPARISON



OUR SUPER FLOODLIGHT CRI>85

NORMAL LIGHT C.R.I. 70



TECHNICAL DATA

ARTICLE NUMBER	RL-600-WW-XX	RL-600-NW-XX	RL-600-CW-XX
NAME OF PRODUCT	SUPER FLOODLIGHT 600W		
INNER CARTON	1	1	1
MASTER CARTON	1	1	1
WEIGHT SINGLE PIECE	26 Kg	26 Kg	26 Kg

GENERAL CHARACTERISTICS

MAIN APPLICATION	Sport field, Stadium, Tunnel, Light tower	Sport field, Stadium, Tunnel, Light tower	Sport field, Stadium, Tunnel, Light tower
NOMINAL LIFETIME	> 80.000 hours	> 80.000 hours	> 80.000 hours
SOURCE (LED TYPE)	72 CREE Xlamp	72 CREE Xlamp	72 CREE Xlamp
IP RATE	IP 67	IP 67	IP 67

LIGHTING DATA

COLOR TEMPERATURE	3.000K	4.000K	5.700K
CRI	>88	>88	>88
LUMINOUS FLUX	>85.000 Lm	>90.000 Lm	>95.000 Lm
LLMF (LUMEN MAINTENANCE)	70% AFTER 50.000 hrs	70% AFTER 50.000 hrs	70% AFTER 50.000 hrs
RATED BEAM ANGLE	10°(XX=10), 24°(XX=24), 38°(XX=38), 60°(XX=60), 90°(XX=90), 120°(XX=120)		

ELECTRICAL DATA

SYSTEM POWER	600W	600W	600W
START TIME (SECOND)	<1 S	<1 S	<1 S
WARM-UP TIME TO 60% LIGHT OUTPUT	INSTANT FULL LIGHT	INSTANT FULL LIGHT	INSTANT FULL LIGHT
INPUT VOLTAGE	AC 90-305V	AC 90-305V	AC 90-305V
FREQUENCY	50/60 Hz	50/60 Hz	50/60 Hz
POWER FACTOR	> 95	> 95	> 95
DIMMABLE	1-10V, TRIAC AND DALI AVAILABLE		
ENERGY SAVING	YES	YES	YES
WORKING TEMPERATURE	-40°/65°C	-40°/65°C	-40°/65°C
HUMIDITY	10-90%	10-90%	10-90%

DIMENSION

DIMENSION OF THE PRODUCT	457*872*104 mm	457*872*104 mm	457*872*104 mm
CUTOUT	NONE	NONE	NONE

APPROVAL & APPLICATIONS CHARS

VDE MARKING	IN PROCESS	IN PROCESS	IN PROCESS
CE MARKING	YES	YES	YES
UL MARKING	IN PROCESS	IN PROCESS	IN PROCESS
ROHS COMPLIANCE	YES	YES	YES

SUPER FLOODLIGHT 800W

RL SUPER FLOODLIGHT: THE BEST QUALITY EVER SEEN!

The RL Super Floodlight is the premium best product of our outdoor catalogue. With a power range between 100W and 3.000W and an opening angle from 10° to 120°, it is the ideal product for outdoor applications from football field to highway tunnels.

RL SUPER FLOODLIGHT: LA MIGLIORE QUALITÀ MAI VISTA PRIMA!

La RL Super Floodlight è il miglior prodotto presente nel nostro catalogo da esterno. Con un range di potenza compreso tra 100W e 3.000W e un angolo di apertura da 10° a 120° è il prodotto ideale per le applicazioni esterne, dal campo da calcio alle gallerie autostradali.

RL SUPER FLOODLIGHT: BESTE QUALITÄT NOCH NIE GESEHEN!

Die RL Super Floodlight sind die besten Produkte zur äußerlichen Anwendung in unserem Katalog. Mit einer Skala von Leistung zwischen 100W und 3.000W und Öffnungswinkel von 10° bis 120°, dieser LED-Strahler ist das beste Produkt für Außenbereiche, von Fußballplatz bis Autobahntunnel.

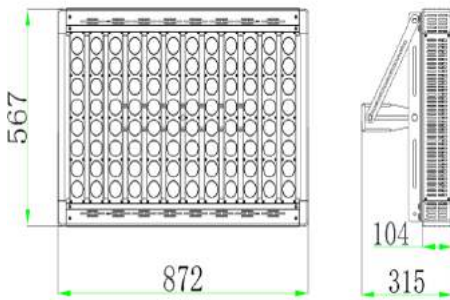

C.R.I. COMPARISON

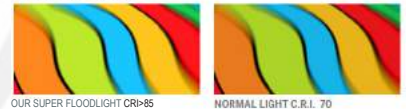

TECHNICAL DATA

ARTICLE NUMBER	RL-800-WW-XX	RL-800-NW-XX	RL-800-CW-XX
NAME OF PRODUCT		SUPER FLOODLIGHT 800W	
INNER CARTON	1	1	1
MASTER CARTON	1	1	1
WEIGHT SINGLE PIECE	31 Kg	31 Kg	31 Kg

GENERAL CHARACTERISTICS

MAIN APPLICATION	Sport field, Stadium, Tunnel, Light tower	Sport field, Stadium, Tunnel, Light tower	Sport field, Stadium, Tunnel, Light tower
NOMINAL LIFETIME	> 80.000 hours	> 80.000 hours	> 80.000 hours
SOURCE (LED TYPE)	96 CREE Xlamp	96 CREE Xlamp	96 CREE Xlamp
IP RATE	IP 67	IP 67	IP 67

LIGHTING DATA

COLOR TEMPERATURE	3.000K	4.000K	5.700K
CRI	>88	>88	>88
LUMINOUS FLUX	>114.000 Lm	>120.000 Lm	>126.000 Lm
LLMF (LUMEN MAINTENANCE)	70% AFTER 50.000 hrs	70% AFTER 50.000 hrs	70% AFTER 50.000 hrs
RATED BEAM ANGLE	10°(XX=10), 24°(XX=24), 38°(XX=38), 60°(XX=60), 90°(XX=90), 120°(XX=120)		

ELECTRICAL DATA

SYSTEM POWER	800W	800W	800W
START TIME (SECOND)	<1 S	<1 S	<1 S
WARM-UP TIME TO 60% LIGHT OUTPUT	INSTANT FULL LIGHT	INSTANT FULL LIGHT	INSTANT FULL LIGHT
INPUT VOLTAGE	AC 90-305V	AC 90-305V	AC 90-305V
FREQUENCY	50/60 Hz	50/60 Hz	50/60 Hz
POWER FACTOR	> 95	> 95	> 95
DIMMABLE		1-10V, TRIAC AND DALI AVAILABLE	
ENERGY SAVING	YES	YES	YES
WORKING TEMPERATURE	-40°/65°C	-40°/65°C	-40°/65°C
HUMIDITY	10-90%	10-90%	10-90%

DIMENSION

DIMENSION OF THE PRODUCT	567*872*280 mm	567*872*280 mm	567*872*280 mm
CUTOUT	NONE	NONE	NONE

APPROVAL & APPLICATIONS CHARS

VDE MARKING	IN PROCESS	IN PROCESS	IN PROCESS
CE MARKING	YES	YES	YES
UL MARKING	IN PROCESS	IN PROCESS	IN PROCESS
ROHS COMPLIANCE	YES	YES	YES

SUPER FLOODLIGHT 1.000W

RL SUPER FLOODLIGHT: THE BEST QUALITY EVER SEEN!

The RL Super Floodlight is the premium best product of our outdoor catalogue. With a power range between 100W and 3.000W and an opening angle from 10° to 120°, it is the ideal product for outdoor applications from football field to highway tunnels.

RL SUPER FLOODLIGHT: LA MIGLIORE QUALITÀ MAI VISTA PRIMA!

La RL Super Floodlight è il miglior prodotto presente nel nostro catalogo da esterno. Con un range di potenza compreso tra 100W e 3.000W e un angolo di apertura da 10° a 120° è il prodotto ideale per le applicazioni esterne, dal campo da calcio alle gallerie autostradali.

RL SUPER FLOODLIGHT: BESTE QUALITÄT NOCH NIE GESEHEN!

Die RL Super Floodlight sind die besten Produkte zur äußerlichen Anwendung in unserem Katalog.

Mit einer Skala von Leistung zwischen 100W und 3.000W und Öffnungswinkel von 10° bis 120°, dieser LED-Strahler ist das beste Produkt für Außenbereiche, von Fußballplatz bis Autobahntunnel.

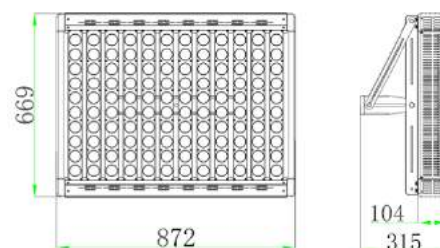

C.R.I. COMPARISON



OUR SUPER FLOODLIGHT CRI>85

NORMAL LIGHT C.R.I. 70



TECHNICAL DATA

ARTICLE NUMBER	RL-1000-WW-XX	RL-1000-NW-XX	RL-1000-CW-XX
NAME OF PRODUCT		SUPER FLOODLIGHT 1000W	
INNER CARTON	1	1	1
MASTER CARTON	1	1	1
WEIGHT SINGLE PIECE	37 Kg	37 Kg	37 Kg

GENERAL CHARACTERISTICS

MAIN APPLICATION	Sport field, Stadium, Tunnel, Light tower	Sport field, Stadium, Tunnel, Light tower	Sport field, Stadium, Tunnel, Light tower
NOMINAL LIFETIME	> 80.000 hours	> 80.000 hours	> 80.000 hours
SOURCE (LED TYPE)	120 CREE Xlamp	120 CREE Xlamp	120 CREE Xlamp
IP RATE	IP 67	IP 67	IP 67

LIGHTING DATA

COLOR TEMPERATURE	3.000K	4.000K	5.700K
CRI	>88	>88	>88
LUMINOUS FLUX	>142.500 Lm	>150.000 Lm	>157.500Lm
LLMF (LUMEN MAINTENANCE)	70% AFTER 50.000 hrs	70% AFTER 50.000 hrs	70% AFTER 50.000 hrs
RATED BEAM ANGLE	10°(XX=10), 24°(XX=24), 38°(XX=38), 60°(XX=60), 90°(XX=90), 120°(XX=120)		

ELECTRICAL DATA

SYSTEM POWER	1.000W	1.000W	1.000W
START TIME (SECOND)	<1 S	<1 S	<1 S
WARM-UP TIME TO 60% LIGHT OUTPUT	INSTANT FULL LIGHT	INSTANT FULL LIGHT	INSTANT FULL LIGHT
INPUT VOLTAGE	AC 90-305V	AC 90-305V	AC 90-305V
FREQUENCY	50/60 Hz	50/60 Hz	50/60 Hz
POWER FACTOR	> 95	> 95	> 95
DIMMABLE		1-10V, TRIAC AND DALI AVAILABLE	
ENERGY SAVING	YES	YES	YES
WORKING TEMPERATURE	-40°/65°C	-40°/65°C	-40°/65°C
HUMIDITY	10-90%	10-90%	10-90%

DIMENSION

DIMENSION OF THE PRODUCT	669*872*280 mm	669*872*280 mm	669*872*280 mm
CUTOUT	NONE	NONE	NONE

APPROVAL & APPLICATIONS CHARS

VDE MARKING	IN PROCESS	IN PROCESS	IN PROCESS
CE MARKING	YES	YES	YES
UL MARKING	IN PROCESS	IN PROCESS	IN PROCESS
ROHS COMPLIANCE	YES	YES	YES

SUPER FLOODLIGHT 1.500W

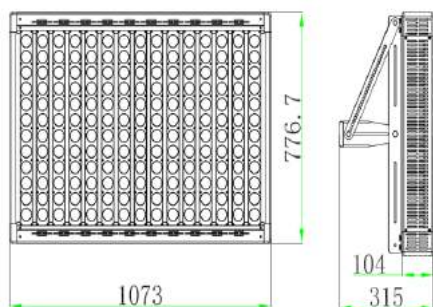

C.R.I. COMPARISON

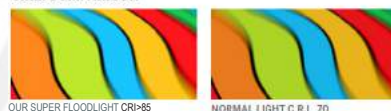

RL SUPER FLOODLIGHT: THE BEST QUALITY EVER SEEN!

The RL Super Floodlight is the premium best product of our outdoor catalogue. With a power range between 100W and 3.000W and an opening angle from 10° to 120°, it is the ideal product for outdoor applications from football field to highway tunnels.

RL SUPER FLOODLIGHT: LA MIGLIORE QUALITÀ MAI VISTA PRIMA!

La RL Super Floodlight è il miglior prodotto presente nel nostro catalogo da esterno. Con un range di potenza compreso tra 100W e 3.000W e un angolo di apertura da 10° a 120° è il prodotto ideale per le applicazioni esterne, dal campo da calcio alle gallerie autostradali.

RL SUPER FLOODLIGHT: BESTE QUALITÄT NOCH NIE GESEHEN!

Die RL Super Floodlight sind die besten Produkte zur äußerlichen Anwendung in unserem Katalog.

Mit einer Skala von Leistung zwischen 100W und 3.000W und Öffnungswinkel von 10° bis 120°, dieser LED-Strahler ist das beste Produkt für Außenbereiche, von Fußballplatz bis Autobahntunnel.

TECHNICAL DATA

ARTICLE NUMBER	RL-1500-WW-XX	RL-1500-NW-XX	RL-1500-CW-XX
NAME OF PRODUCT	SUPER FLOODLIGHT 1500W		
INNER CARTON	1	1	1
MASTER CARTON	1	1	1
WEIGHT SINGLE PIECE	48 Kg	48 Kg	48 Kg

GENERAL CHARACTERISTICS

MAIN APPLICATION	Sport field, Stadium, Tunnel, Light tower	Sport field, Stadium, Tunnel, Light tower	Sport field, Stadium, Tunnel, Light tower
NOMINAL LIFETIME	> 80.000 hours	> 80.000 hours	> 80.000 hours
SOURCE (LED TYPE)	180 CREE Xlamp	180 CREE Xlamp	180 CREE Xlamp
IP RATE	IP 67	IP 67	IP 67

LIGHTING DATA

COLOR TEMPERATURE	3.000K	4.000K	5.700K
CRI	>88	>88	>88
LUMINOUS FLUX	>213.000 Lm	>225.000 Lm	>237.000 Lm
LLMF (LUMEN MAINTENANCE)	70% AFTER 50.000 hrs	70% AFTER 50.000 hrs	70% AFTER 50.000 hrs
RATED BEAM ANGLE	10°(XX=10), 24°(XX=24), 38°(XX=38), 60°(XX=60), 90°(XX=90), 120°(XX=120)		

ELECTRICAL DATA

SYSTEM POWER	1.500W	1.500W	1.500W
START TIME (SECOND)	<1 S	<1 S	<1 S
WARM-UP TIME TO 60% LIGHT OUTPUT	INSTANT FULL LIGHT	INSTANT FULL LIGHT	INSTANT FULL LIGHT
INPUT VOLTAGE	AC 90-305V	AC 90-305V	AC 90-305V
FREQUENCY	50/60 Hz	50/60 Hz	50/60 Hz
POWER FACTOR	> 95	> 95	> 95
DIMMABLE	1-10V, TRIAC AND DALI AVAILABLE		
ENERGY SAVING	YES	YES	YES
WORKING TEMPERATURE	-40°/65°C	-40°/65°C	-40°/65°C
HUMIDITY	10-90%	10-90%	10-90%

DIMENSION

DIMENSION OF THE PRODUCT	1.073*776,7*104 mm	1.073*776,7*104 mm	1.073*776,7*104 mm
CUTOUT	NONE	NONE	NONE

APPROVAL & APPLICATIONS CHARS

VDE MARKING	IN PROCESS	IN PROCESS	IN PROCESS
CE MARKING	YES	YES	YES
UL MARKING	IN PROCESS	IN PROCESS	IN PROCESS
ROHS COMPLIANCE	YES	YES	YES

SUPER FLOODLIGHT 2.000W

RL SUPER FLOODLIGHT: THE BEST QUALITY EVER SEEN!

The RL Super Floodlight is the premium best product of our outdoor catalogue. With a power range between 100W and 3.000W and an opening angle from 10° to 120°, it is the ideal product for outdoor applications from football field to highway tunnels.

RL SUPER FLOODLIGHT: LA MIGLIORE QUALITÀ MAI VISTA PRIMA!

La RL Super Floodlight è il miglior prodotto presente nel nostro catalogo da esterno. Con un range di potenza compreso tra 100W e 3.000W e un angolo di apertura da 10° a 120° è il prodotto ideale per le applicazioni esterne, dal campo da calcio alle gallerie autostradali.

RL SUPER FLOODLIGHT: BESTE QUALITÄT NOCH NIE GESEHEN!

Die RL Super Floodlight sind die besten Produkte zur äußerlichen Anwendung in unserem Katalog.

Mit einer Skala von Leistung zwischen 100W und 3.000W und Öffnungswinkel von 10° bis 120°, dieser LED-Strahler ist das beste Produkt für Außenbereiche, von Fußballplatz bis Autobahntunnel.

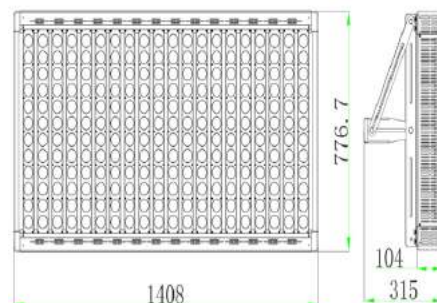

C.R.I. COMPARISON



OUR SUPER FLOODLIGHT CRI>85

NORMAL LIGHT C.R.I. 70



TECHNICAL DATA

ARTICLE NUMBER	RL-2000-WW-XX	RL-2000-NW-XX	RL-2000-CW-XX
NAME OF PRODUCT		SUPER FLOODLIGHT 2000W	
INNER CARTON	1	1	1
MASTER CARTON	1	1	1
WEIGHT SINGLE PIECE	60 Kg	60 Kg	60 Kg

GENERAL CHARACTERISTICS

MAIN APPLICATION	Sport field, Stadium, Tunnel, Light tower	Sport field, Stadium, Tunnel, Light tower	Sport field, Stadium, Tunnel, Light tower
NOMINAL LIFETIME	> 80.000 hours	> 80.000 hours	> 80.000 hours
SOURCE (LED TYPE)	240 CREE Xlamp	240 CREE Xlamp	240 CREE Xlamp
IP RATE	IP 67	IP 67	IP 67

LIGHTING DATA

COLOR TEMPERATURE	3.000K	4.000K	5.700K
CRI	>88	>88	>88
LUMINOUS FLUX	>285.000 Lm	>300.000 Lm	>315.000Lm
LLMF (LUMEN MAINTENANCE)	70% AFTER 50.000 hrs	70% AFTER 50.000 hrs	70% AFTER 50.000 hrs
RATED BEAM ANGLE	10°(XX=10), 24°(XX=24), 38°(XX=38), 60°(XX=60), 90°(XX=90), 120°(XX=120)		

ELECTRICAL DATA

SYSTEM POWER	2.000W	2.000W	2.000W
START TIME (SECOND)	<1 S	<1 S	<1 S
WARM-UP TIME TO 60% LIGHT OUTPUT	INSTANT FULL LIGHT	INSTANT FULL LIGHT	INSTANT FULL LIGHT
INPUT VOLTAGE	AC 90-305V	AC 90-305V	AC 90-305V
FREQUENCY	50/60 Hz	50/60 Hz	50/60 Hz
POWER FACTOR	> 95	> 95	> 95
DIMMABLE		1-10V, TRIAC AND DALI AVAILABLE	
ENERGY SAVING	YES	YES	YES
WORKING TEMPERATURE	-40°/65°C	-40°/65°C	-40°/65°C
HUMIDITY	10-90%	10-90%	10-90%

DIMENSION

DIMENSION OF THE PRODUCT	1.408*776,7*104 mm	1.408*776,7*104 mm	1.408*776,7*104 mm
CUTOUT	NONE	NONE	NONE

APPROVAL & APPLICATIONS CHARS

VDE MARKING	IN PROCESS	IN PROCESS	IN PROCESS
CE MARKING	YES	YES	YES
UL MARKING	IN PROCESS	IN PROCESS	IN PROCESS
ROHS COMPLIANCE	YES	YES	YES

SUPER FLOODLIGHT 3.000W



RL SUPER FLOODLIGHT: THE BEST QUALITY EVER SEEN!

The RL Super Floodlight is the premium best product of our outdoor catalogue. With a power range between 100W and 3.000W and an opening angle from 10° to 120°, it is the ideal product for outdoor applications from football field to highway tunnels.

RL SUPER FLOODLIGHT: LA MIGLIORE QUALITÀ MAI VISTA PRIMA!

La RL Super Floodlight è il miglior prodotto presente nel nostro catalogo da esterno. Con un range di potenza compreso tra 100W e 3.000W e un angolo di apertura da 10° a 120° è il prodotto ideale per le applicazioni esterne, dal campo da calcio alle gallerie autostradali.

RL SUPER FLOODLIGHT: BESTE QUALITÄT NOCH NIE GESEHEN!

Die RL Super Floodlight sind die besten Produkte zur äußerlichen Anwendung in unserem Katalog.

Mit einer Skala von Leistung zwischen 100W und 3.000W und Öffnungswinkel von 10° bis 120°, dieser LED-Strahler ist das beste Produkt für Außenbereiche, von Fußballplatz bis Autobahntunnel.

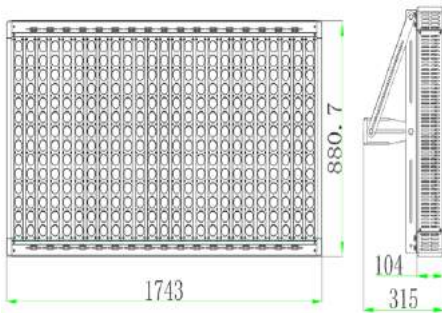

TECHNICAL DATA

ARTICLE NUMBER	RL-3000-WW-XX	RL-3000-NW-XX	RL-3000-CW-XX
NAME OF PRODUCT		SUPER FLOODLIGHT 3000W	
INNER CARTON	1	1	1
MASTER CARTON	1	1	1
WEIGHT SINGLE PIECE	98 Kg	98 Kg	98 Kg

GENERAL CHARACTERISTICS

MAIN APPLICATION	Sport field, Stadium, Tunnel, Light tower	Sport field, Stadium, Tunnel, Light tower	Sport field, Stadium, Tunnel, Light tower
NOMINAL LIFETIME	> 80.000 hours	> 80.000 hours	> 80.000 hours
SOURCE (LED TYPE)	360 CREE Xlamp	360 CREE Xlamp	360 CREE Xlamp
IP RATE	IP 67	IP 67	IP 67

LIGHTING DATA

COLOR TEMPERATURE	3.000K	4.000K	5.700K
CRI	>88	>88	>88
LUMINOUS FLUX	>427.000 Lm	>450.000 Lm	>473.000 Lm
LLMF (LUMEN MAINTENANCE)	70% AFTER 50.000 hrs	70% AFTER 50.000 hrs	70% AFTER 50.000 hrs
RATED BEAM ANGLE	10°(XX=10), 24°(XX=24), 38°(XX=38), 60°(XX=60), 90°(XX=90), 120°(XX=120)		

ELECTRICAL DATA

SYSTEM POWER	3.000W	3.000W	3.000W
START TIME (SECOND)	<1 S	<1 S	<1 S
WARM-UP TIME TO 60% LIGHT OUTPUT	INSTANT FULL LIGHT	INSTANT FULL LIGHT	INSTANT FULL LIGHT
INPUT VOLTAGE	AC 90-305V	AC 90-305V	AC 90-305V
FREQUENCY	50/60 Hz	50/60 Hz	50/60 Hz
POWER FACTOR	> 95	> 95	> 95
DIMMABLE		1-10V, TRIAC AND DALI AVAILABLE	
ENERGY SAVING	YES	YES	YES
WORKING TEMPERATURE	-40°/65°C	-40°/65°C	-40°/65°C
HUMIDITY	10-90%	10-90%	10-90%

DIMENSION

DIMENSION OF THE PRODUCT	1.743*880,7*104 mm	1.743*960*550 mm	1.743*960*550 mm
CUTOUT	NONE	NONE	NONE

APPROVAL & APPLICATIONS CHARS

VDE MARKING	IN PROCESS	IN PROCESS	IN PROCESS
CE MARKING	YES	YES	YES
UL MARKING	IN PROCESS	IN PROCESS	IN PROCESS
ROHS COMPLIANCE	YES	YES	YES

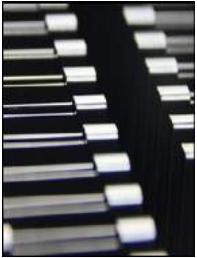

Aluminum alloy heatsink
With electrophoresis treatment

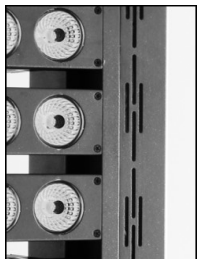

Aluminum alloy housing
With electrostatic spraying



Stainless steel SUS304
Fixed Handle
With electrophoresis
treatment



The heat radiator area of the LED
floodlight is the biggest in the
high-power LED industry at present



Driver inside with ventilation
design, protect it from
the damage of sunshine



SUPER FLOODLIGHT

BEAM ANGLE

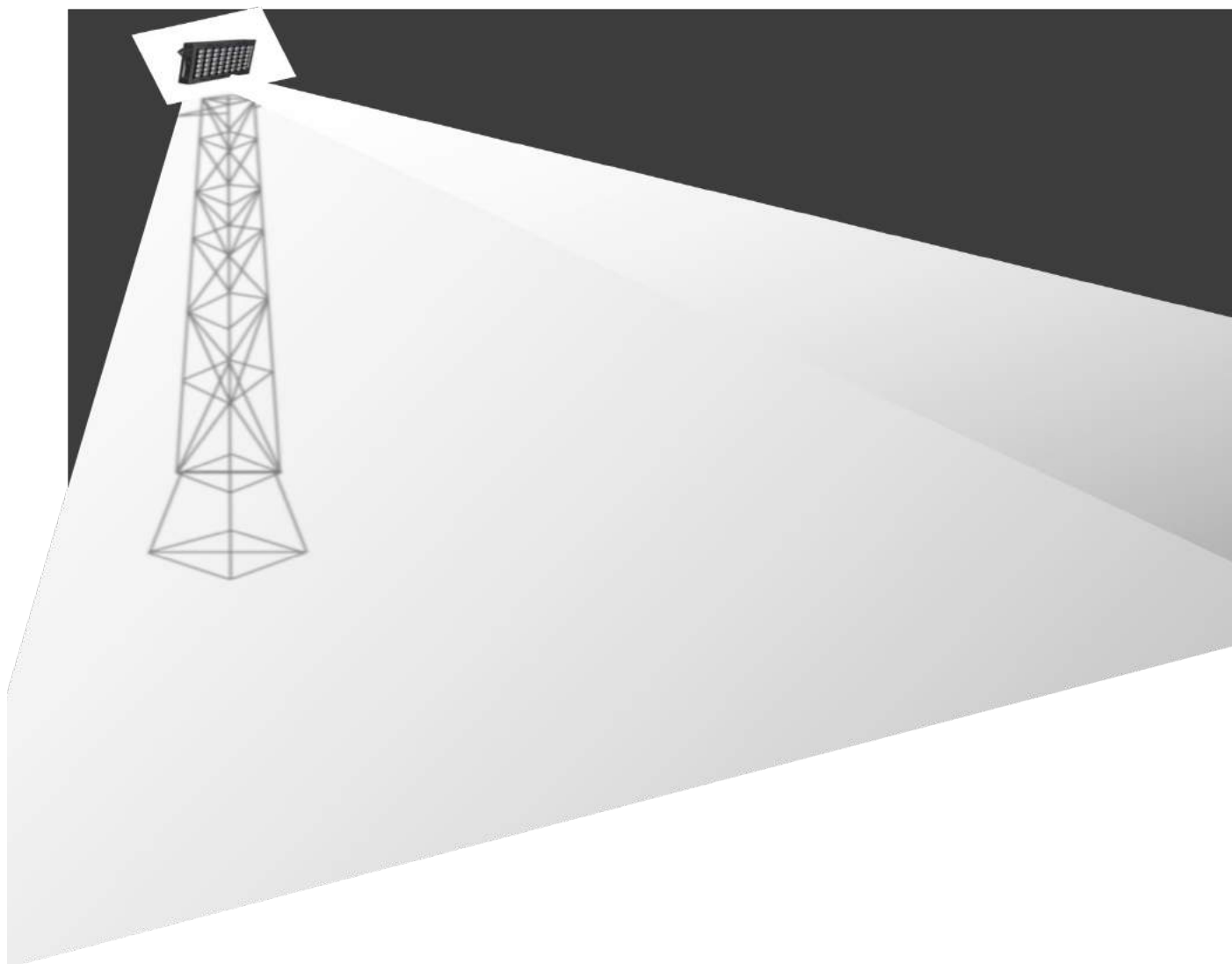
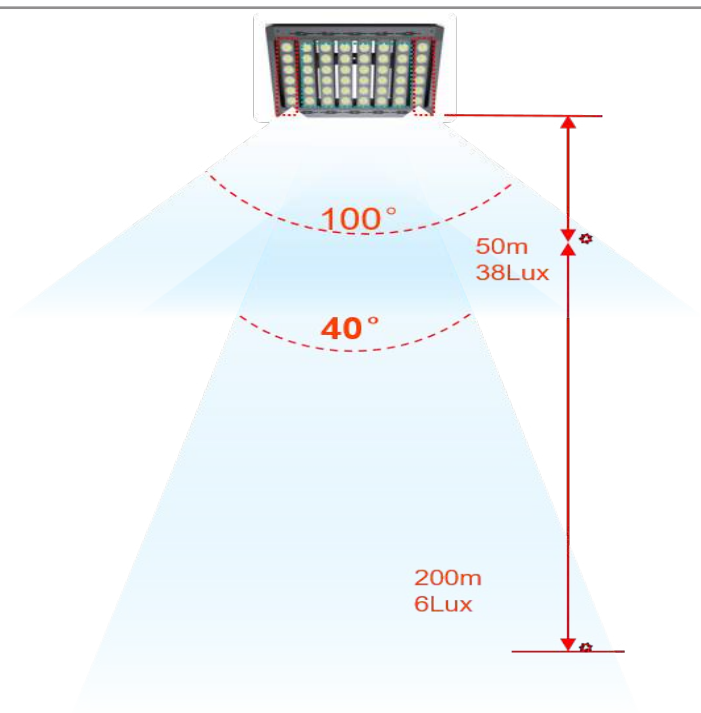
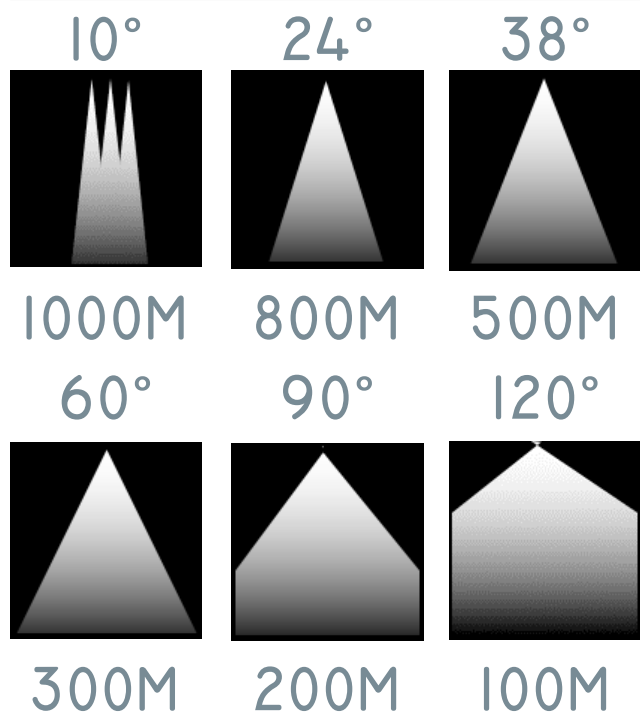

SUPER FLOODLIGHT

INSTALLATION INSTRUCTIONS

Through the screw, choose and adjust the angle of the bracket you need before installaing

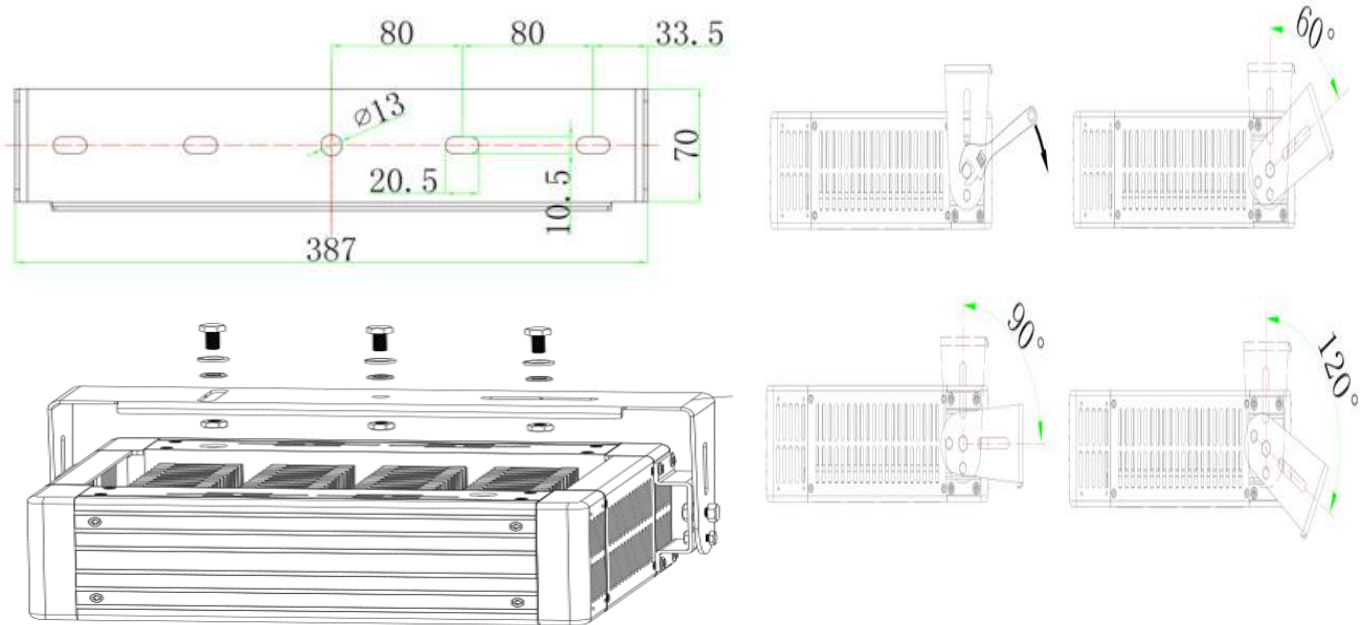

APPLICATIONS

Applied in large sports field lighting, football, basketball, golf and tennis court, racetrack, badminton, roads, high-rise buildings, tower lights, etc. Can also be applied in large square, airport, commercial building, construction engineering, farm, amusement parks, parking lots, harbor, industrial buildings, and other special lighting environment.

