



RL Europe

Your partner in LED



Technical Application Guide for RL EUROPE LED Cylinder

RLPD02D-25W

Introduction



PD02 whole lamp adopts straightforward design with stylish appearance, easy to install, simple and generous, paying more attention to leisure and comfort. It gives space a clear and lively feelings. Different color of surface ring is optional, which could create diversified light atmosphere according to different environment.

The lamp adopts high quality reflector which has good reflective rate and light output > 86%. AL6063 Aluminum radiator in sand blast oxidation treatment provides excellent heat dissipation and corrosion resistance. High lumen COB chip with CRI>80. PF>0.9, THD<20%, passed EMC test with strong anti-jamming capability. Besides, it possesses short-circuit protection and overvoltage protection function, showing high safety performance.

- Up to 70% energy saving compared to standard CFL
- Long lifetime of 50,000 hours
- 10°/24°/36° beam angle
- CCT: 2700K 3000K
4000K 5000K
- No UV/IR light
- Environment friendly, without Mercury or any other hazardous substances
- Internal Driver
- CREE COB

Application notes

- IP20 for indoor use only
- Professional electrician for installation only
- Switch off before installation
- Do not touch when in use
- Keep away from hot steam and corrosive gas

Application Areas

Applicable for residential lighting in bedroom, living room, corridor etc, also suitable for commercial lighting in office, hotel, restaurant etc.

Certificate

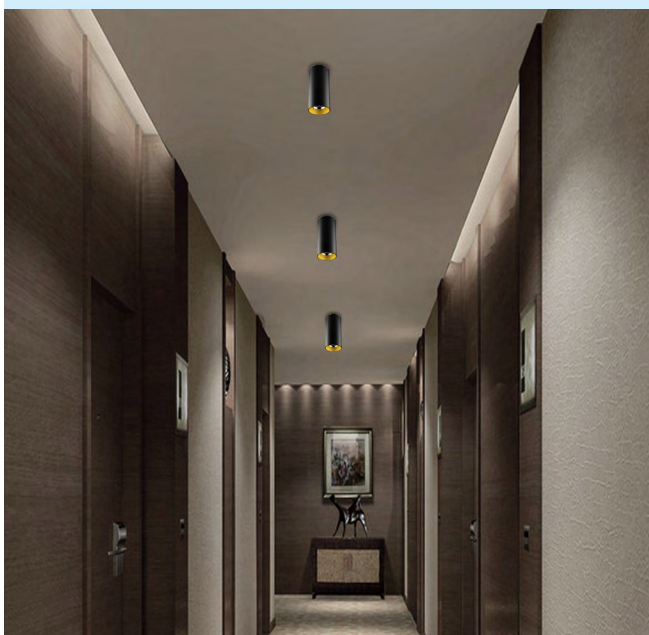

Product Information

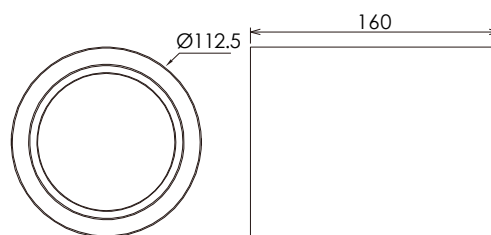

Technical Specifications

Model	Voltage	Power	Power Factor	Lumen (±5%)	CCT	Beam angle	Lifespan	CRI	Dimmable	Dimension
RL-PD02D-25W	AC200-240V	25W	≥0.9	2050	2700K	10°/24°/36°	50,000h	≥80	No	Ø112.5*160mm
				2250	3000K					
				2470	4000K					
				2320	5000K					
RL-PD02D-25W-D	AC200-240V	25W	≥0.9	1970	2700K	10°/24°/36°	50,000h	≥80	Yes	Ø112.5*160mm
				2150	3000K					
				2390	4000K					
				2240	5000K					

Driver data Sheet

Driver data	DIM	Non dim
Input rated Voltage	AC200-240V	AC200-240V
Frequency	50Hz	50/60Hz
Input Voltage	AC200-240V	AC200-240V
Efficiency	≥84%	≥85%
Total load Wattage	25W±5%	25W±5%
Power Factor	≥0.9	≥0.9
Rated input current	≤0.14A	≤0.15A
Full load output Voltage	DC30-40V	DC30-40V
Rated output current	580mA	600mA
Output current range	580mA±5%	600mA±5%
Power tolerance	±5%	±5%
Current output tolerance	±5%	±5%
Dimming range	8%-100%	—
Dimmer	Triac dimmers	—
Short circuit protection	PASS	PASS
Over voltage protection	PASS	PASS
Over temperature protection	PASS	PASS
THD	≤20%	≤20%
Withstand voltage	—	—

Fixture Compatibility

Rated Wattage	Electrical Classification	Ingress Protection	Operating Temp	Operating Humidity	Storage Temp
25W	I	IP20	-20°C~45°C	0~90%	-20°C~65°C

Spectral Distribution

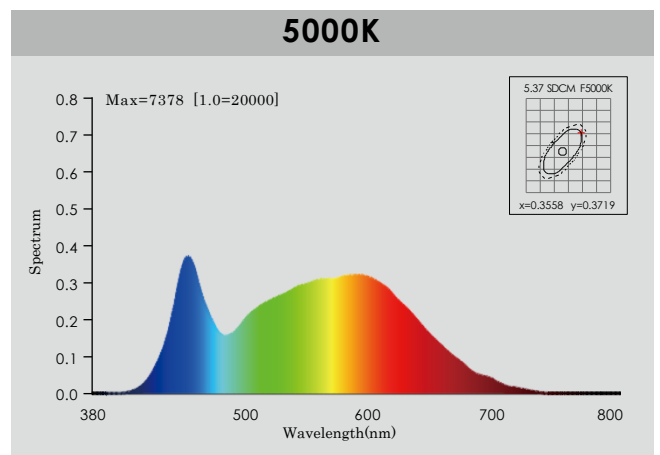
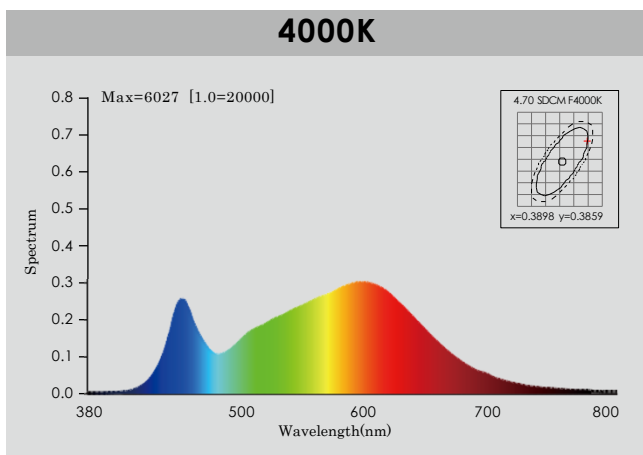
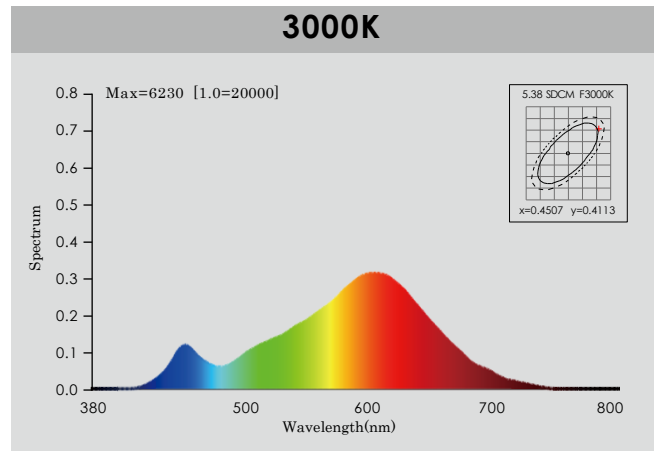
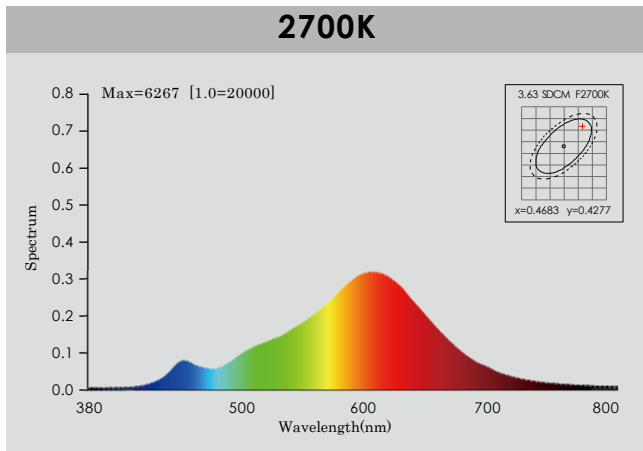

Photometric Diagram

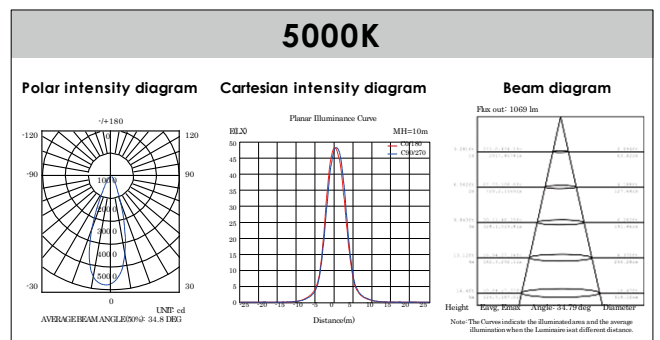
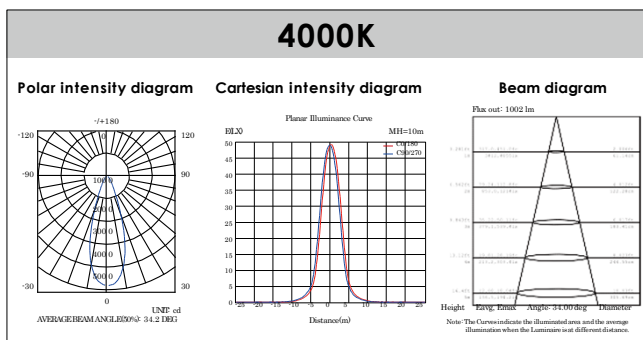
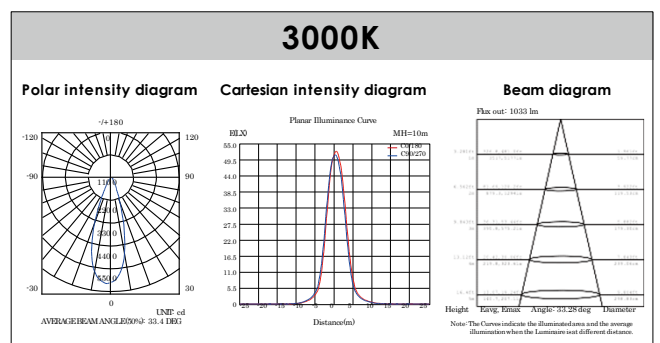
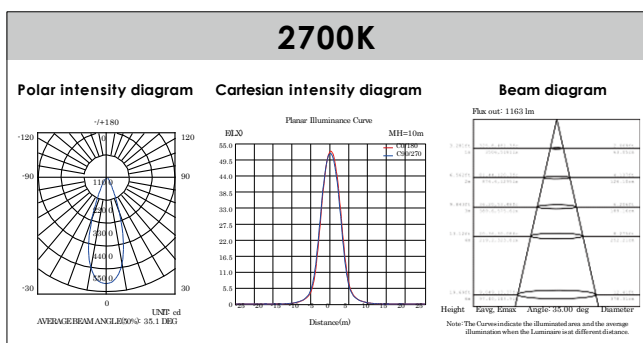

Polar Diagram Comparison

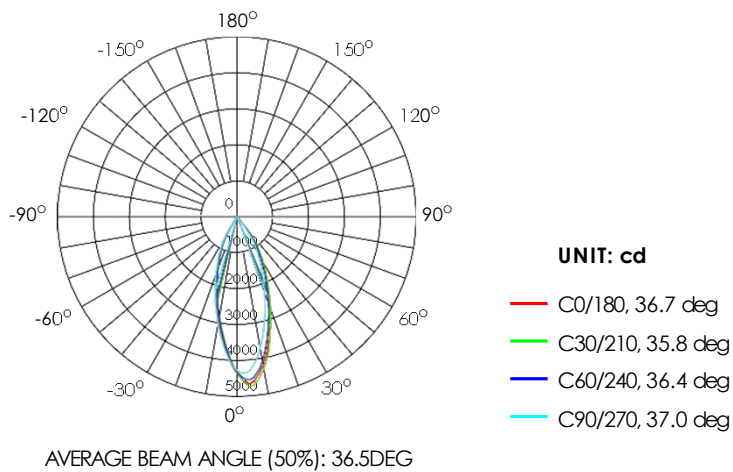

Driver lifetime & LED light decay rate

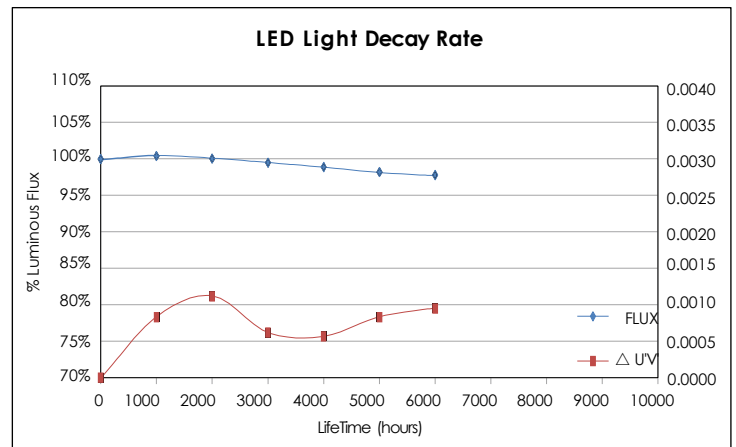
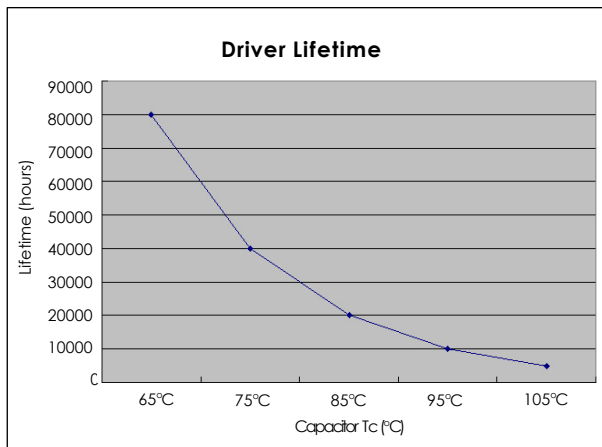

Temperature

- The testing is operated at 25°C
- The lifetime of capacitor, minimum of 5,000 hours if operated at 105°C, will be doubled whenever the temperature drops 10°C
- The highest withstand temperature of IC, MOS could be 120°C
- The highest withstand temperature of LED junction temperature is 150°C

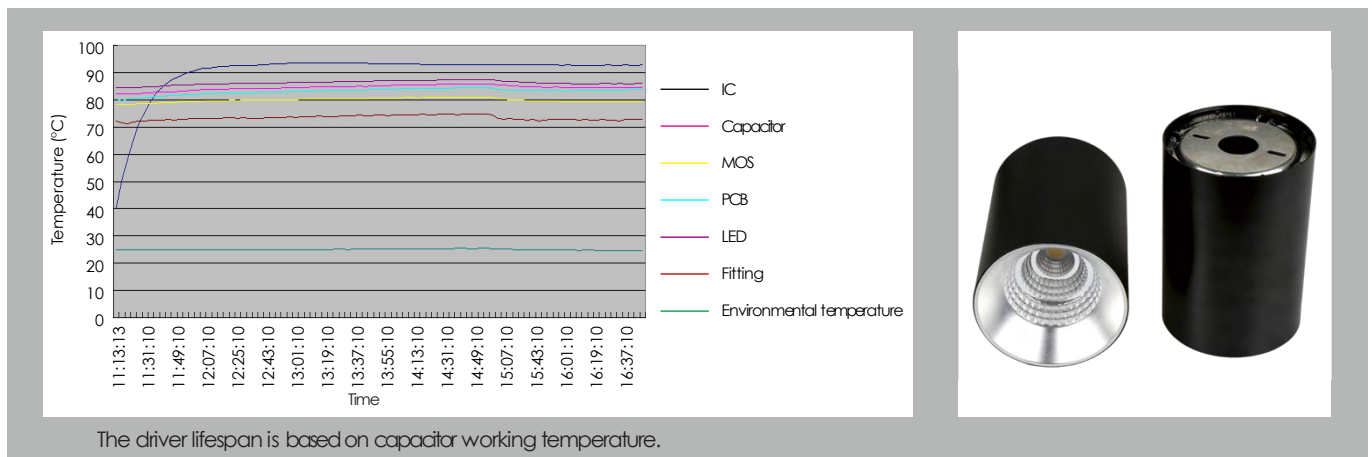

Installation

1

Take out the accessories from accessory box.

2

Determine mounting location and knock the plastic anchor into ceiling, fix bracket with screw into the ceiling.

3

Connect the corresponding polarities between the wire on the ceiling and input wire by screw terminal.

4

After proper alignment and adjustment between lamp and mounting plate, then rotate the lamp clockwise until it is stuck firmly by mounting plate.

Packaging Information

	SIZE(CM)	NW/pc (KGS)	G.W.(KGS)	Q'TY(PCS)
Carton	49.5*37.5*36	0.75	19	24

	CTNS	Q'TY(PCS)	VOLUME(CBM)
20" standard container	372	8928	28
40" standard container	744	17856	56

